

# Montageanleitung

## Korpus

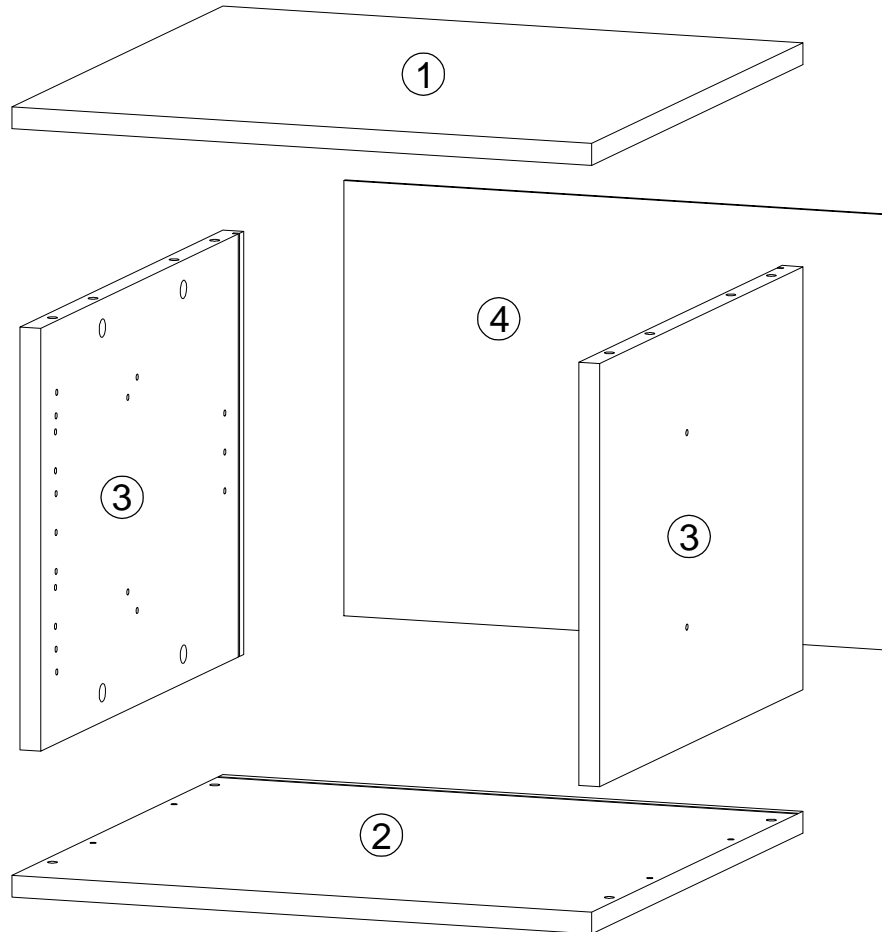
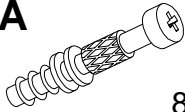
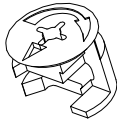
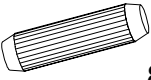
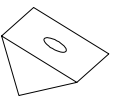
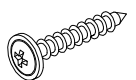

### Beschlagbeutel:

<b>A</b>  8 x	<b>B</b>  8 x	<b>C</b>  30 x 8 8 x
<b>D</b>  4 x	<b>E</b>  3 x 20 4 x	

Für die Montage benötigen Sie folgende Werkzeuge:



Ersatzteilnummer	Bauteilbezeichnung
1	Oberboden
2	Unterboden
3	Aussenseite li. / re.
4	Rückwand

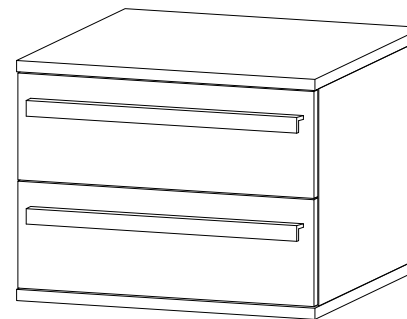

### Korpusmaße

Breite	Tiefe	Höhe
500	500	422
800	500	422
1000	500	422
500	340	422
800	340	422
1000	340	422

Bitte lesen Sie diese Montageanleitung gut durch, da wir für Schäden, die durch falsche Montage entstehen, keine Haftung übernehmen!

